

## OUTLINE

The R1210Nxx2C/xx2D Series are CMOS-based PWM step-up DC/DC Converter controllers, with high accuracy, low supply current.

Each of the R1210Nxx2x Series consists of an oscillator, a PWM circuit, a reference voltage unit, an error amplifier, phase compensation circuit, resistors for voltage detection, a chip enable circuit, a controller against drastic load transient and an output voltage detector. A low ripple, high efficiency step-up DC/DC converter can be composed of this IC with only four external components, or an inductor, a diode, a transistor and a capacitor.

The R1210Nxx2x Series can detect drastic change of output voltage with a circuit controller, the load transient response is improved.

Each of the R1210Nxx2x Series has a driver pin, or 'EXT' pin for external transistor. By connecting a power transistor with low ON-resistance to EXT pin, a large current flows through an inductor, thus, large output current can be supplied.

The built-in chip enable circuit can make the standby mode with ultra low quiescent current.

Since the package for these ICs is small SOT-23-5, high density mounting of the ICs on board is possible.

## FEATURES

- External Components ..... Only an inductor, a diode, a capacitor, and a transistor
- Standby Current ..... Typ. 0 $\mu$ A
- Low Temperature-Drift Coefficient of Output Voltage Typ.  $\pm$ 100ppm/ $^{\circ}$ C
- Output Voltage ..... Stepwise Setting with a step of 0.1V in the range of  
2.2V to 6.0V
- Two choices of Basic Oscillator Frequency ..... 100kHz (xx2C), 180kHz (xx2D)
- Small Package ..... SOT-23-5 (Mini-mold)
- Low Ripple, Low Noise
- Oscillator Start-up Voltage ..... Max. 0.8V

## APPLICATIONS

- Power source for battery-powered equipment.
- Power source for portable communication appliances, cameras, VCRs
- Power source for appliances of which require higher voltage than battery voltage.

## BLOCK DIAGRAMS

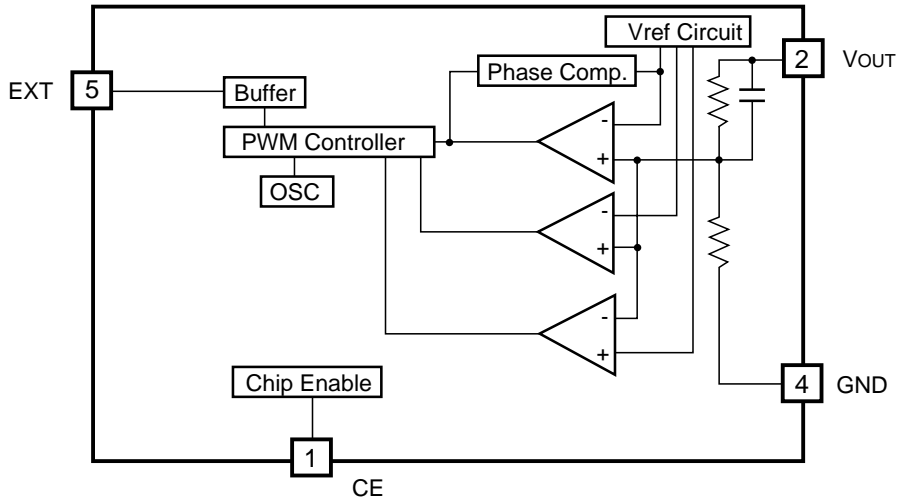

## SELECTION GUIDE

In the R1210N Series, the output voltage, the oscillator frequency, the optional function, and the taping type for the ICs can be selected at the user's request.

The selection can be made by designating the part number as shown below;

R1210N $\overset{\uparrow}{\text{xx}}\overset{\uparrow}{\text{2}}\overset{\uparrow}{\text{x}}\overset{\uparrow}{\text{xx}}$  ← Part Number  
                   ↑ ↑ ↑ ↑  
                   a b c d

Code	Contents
a	Setting Output Voltage( $V_{OUT}$ ): Stepwise setting with a step of 0.1V in the range of 2.2V to 6.0V
b	Designation of Driver 2: External Tr. Driver
c	Designation of Oscillator Frequency C: 100kHz D: 180kHz
d	Designation of Taping Type; Ex.: TR, TL (refer to Taping Specification) "TR" is prescribed as a standard.

## PIN CONFIGURATION

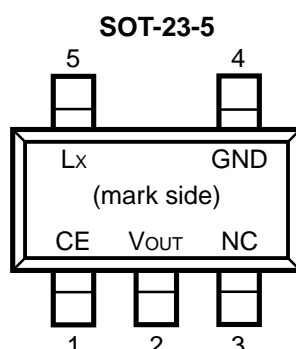

## PIN DESCRIPTIONS

Pin No	Symbol	Pin Description
1	CE	Chip Enable Pin
2	V <sub>OUT</sub>	Pin for Output Voltage
3	NC	No Connection
4	GND	Ground Pin
5	EXT	External Transistor Drive Pin

## ABSOLUTE MAXIMUM RATINGS

Symbol	Item	Rating	Unit
V <sub>OUT</sub>	V <sub>OUT</sub> Pin Output Voltage	9.0	V
V <sub>EXT</sub>	EXT Pin Output Voltage	-0.3~ V <sub>OUT</sub> +0.3	V
V <sub>CE</sub>	CE Pin Input Voltage	9.0	V
I <sub>EXT</sub>	EXT Pin Output Current	±40	mA
P <sub>D</sub>	Power Dissipation	250	mW
T <sub>opt</sub>	Operating Temperature Range	-40 ~ +85	°C
T <sub>stg</sub>	Storage Temperature Range	-55 ~ +125	°C

## ELECTRICAL CHARACTERISTICS

## • R1210Nxx2x

T<sub>opt</sub>=25°C

Symbol	Item	Conditions	Min.	Typ.	Max.	Unit
V <sub>OUT</sub>	Output Voltage	V <sub>IN</sub> =V <sub>SET</sub> ×0.6, I <sub>OUT</sub> =1mA	×0.975		×1.025	V
V <sub>IN</sub>	Maximum Input Voltage				8	V
ΔV <sub>OUT</sub> / ΔT	Step-up Output Voltage Temperature Coefficient	-40°C ≤ T <sub>opt</sub> ≤ 85°C		±100		ppm/°C
V <sub>start</sub>	Start-up Voltage	V <sub>IN</sub> =0V→2V			0.8	V
I <sub>standby</sub>	Supply Current 3(Standby)	V <sub>OUT</sub> =6.5V, V <sub>CE</sub> =0V			0.5	μA
I <sub>DD1</sub>	Supply Current 1	V <sub>OUT</sub> = V <sub>SET</sub> ×0.96 EXT at no load 2.2V ≤ V <sub>SET</sub> ≤ 2.4V		18	35	μA (xx2C)
				23	45	μA (xx2D)
		V <sub>OUT</sub> = V <sub>SET</sub> ×0.96 EXT at no load 2.5V ≤ V <sub>SET</sub> ≤ 3.0V		20	40	μA (xx2C)
				25	50	μA (xx2D)
		V <sub>OUT</sub> = V <sub>SET</sub> ×0.96 EXT at no load 3.1V ≤ V <sub>SET</sub> ≤ 3.9V		25	50	μA (xx2C)
				30	60	μA (xx2D)
		V <sub>OUT</sub> = V <sub>SET</sub> ×0.96 EXT at no load 4.0V ≤ V <sub>SET</sub> ≤ 4.4V		30	60	μA (xx2C)
				35	70	μA (xx2D)
		V <sub>OUT</sub> = V <sub>SET</sub> ×0.96 EXT at no load 4.5V ≤ V <sub>SET</sub> ≤ 4.9V		35	70	μA (xx2C)
				40	80	μA (xx2D)
		V <sub>OUT</sub> = V <sub>SET</sub> ×0.96 EXT at no load 5.0V ≤ V <sub>SET</sub> ≤ 5.4V		45	90	μA (xx2C)
				50	100	μA (xx2D)
		V <sub>OUT</sub> = V <sub>SET</sub> ×0.96 EXT at no load 5.5V ≤ V <sub>SET</sub> ≤ 6.0V		50	100	μA (xx2C)
				55	110	μA (xx2D)
I <sub>DD2</sub>	Supply Current 2	V <sub>OUT</sub> =V <sub>CE</sub> =V <sub>SET</sub> +0.5		10	15	μA (xx2C)
				15	22	μA (xx2D)

Symbol	Item	Conditions	Min.	Typ.	Max.	Unit
I <sub>EXTH</sub>	EXT "H" Output Current	$2.2V \leq V_{SET} \leq 2.5V$ $V_{EXT}=V_{OUT}-0.4V$			-1.0	mA
		$2.6V \leq V_{SET} \leq 3.0V$ $V_{EXT}=V_{OUT}-0.4V$			-2.0	mA
		$3.1V \leq V_{SET} \leq 3.5V$ $V_{EXT}=V_{OUT}-0.4V$			-2.5	mA
		$3.6V \leq V_{SET} \leq 4.0V$ $V_{EXT}=V_{OUT}-0.4V$			-3.0	mA
		$4.1V \leq V_{SET} \leq 4.5V$ $V_{EXT}=V_{OUT}-0.4V$			-3.5	mA
		$4.6V \leq V_{SET} \leq 5.0V$ $V_{EXT}=V_{OUT}-0.4V$			-4.0	mA
		$5.1V \leq V_{SET} \leq 5.5V$ $V_{EXT}=V_{OUT}-0.4V$			-4.5	mA
		$5.6V \leq V_{SET} \leq 6.0V$ $V_{EXT}=V_{OUT}-0.4V$			-5.0	mA
fosc	Maximum Oscillator Frequency	$V_{OUT}=V_{CE}=V_{SET} \times 0.96$	80	100	120	kHz (xx2C)
			144	180	216	kHz (xx2D)
$\Delta fosc / \Delta T$	Oscillator Frequency Temperature Coefficient	$-40^{\circ}C \leq T_{opt} \leq 85^{\circ}C$		0.5		kHz/ $^{\circ}C$ (xx2C)
				0.6		kHz/ $^{\circ}C$ (xx2D)
Maxdty	Oscillator Maximum Duty Cycle	$V_{OUT}=V_{CE}=V_{SET} \times 0.96$ , (V <sub>EXT</sub> "H" Side)	70	85	97	%
I <sub>EXTL</sub>	EXT "L" Output Current	$2.2V \leq V_{SET} \leq 2.5V, V_{EXT}=0.4V$	1.0			mA
		$2.6V \leq V_{SET} \leq 3.0V, V_{EXT}=0.4V$	2.0			mA
		$3.1V \leq V_{SET} \leq 3.5V, V_{EXT}=0.4V$	2.5			mA
		$3.6V \leq V_{SET} \leq 4.0V, V_{EXT}=0.4V$	3.0			mA
		$4.1V \leq V_{SET} \leq 4.5V, V_{EXT}=0.4V$	3.5			mA
		$4.6V \leq V_{SET} \leq 5.0V, V_{EXT}=0.4V$	4.0			mA
		$5.1V \leq V_{SET} \leq 5.5V, V_{EXT}=0.4V$	4.5			mA
		$5.6V \leq V_{SET} \leq 6.0V, V_{EXT}=0.4V$	5.0			mA
V <sub>CEH</sub>	CE "H" Input Voltage	$V_{OUT}=V_{SET} \times 0.96$	0.9			V
V <sub>CEL</sub>	CE "L" Input Voltage	$V_{OUT}=V_{SET} \times 0.96$			0.3	V
I <sub>CEH</sub>	CE "H" Input Current	$V_{OUT}=V_{CE}=6.5V$	-0.1	0.0	0.1	$\mu A$
I <sub>CEL</sub>	CE "L" Input Current	$V_{IN}=6.5V, V_{CE}=0V$	-0.1	0.0	0.1	$\mu A$

\*Note: V<sub>SET</sub> means setting Output Voltage.

## TEST CIRCUITS

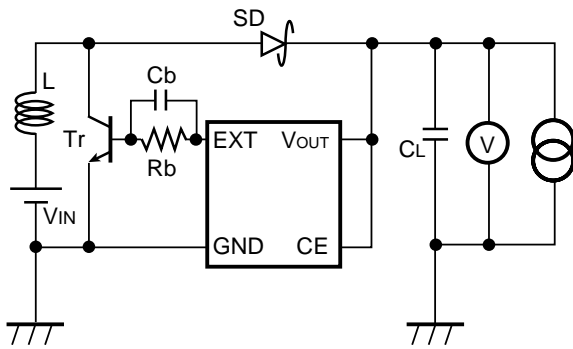

**Test Circuit 1**

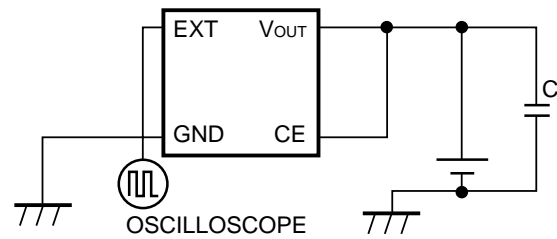

**Test Circuit 2**

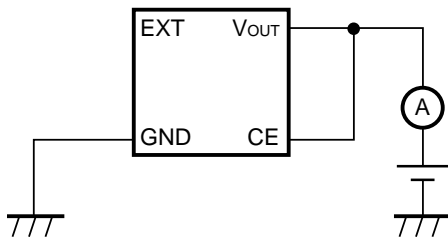

**Test Circuit 3**

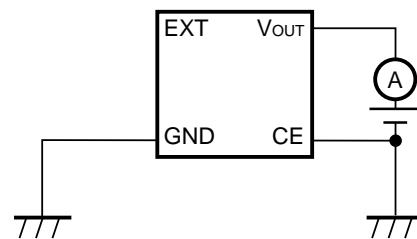

**Test Circuit 4**

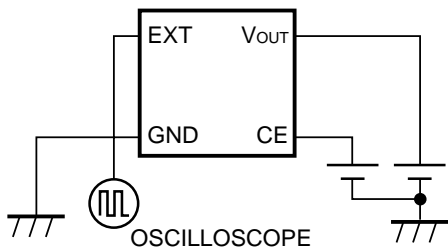

**Test Circuit 5**

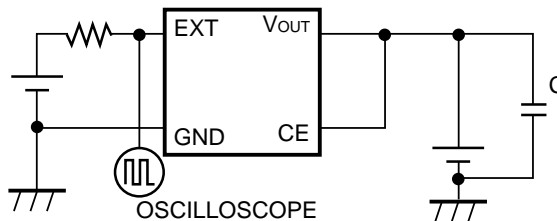

**Test Circuit 6**

Inductor (L)	: 27 $\mu$ H (Sumida Electric Co., Ltd. CD104)
Diode (SD)	: RB491D (Rohm, Schottky Type)
Capacitor (CL)	: 47 $\mu$ F $\times$ 2 (Tantalum Type)
Transistor (Tr)	: 2SD1628G
Base Resistor (Rb)	: 300 $\Omega$
Base Capacitor (Cb)	: 0.01 $\mu$ F (Ceramic Type)

The typical characteristics were obtained by use of these test circuits.

- Test Circuit 1 : Typical Characteristics 1) 2) 3) 4) 5)
- Test Circuit 2 : Typical Characteristics 9) 10)
- Test Circuit 3 : Typical Characteristics 6) 7)
- Test Circuit 4 : Typical Characteristics 8)
- Test Circuit 5 : Typical Characteristics 11)
- Test Circuit 6 : Typical Characteristics 12)

## TYPICAL CHARACTERISTICS

### 1) Output Voltage vs. Output Current

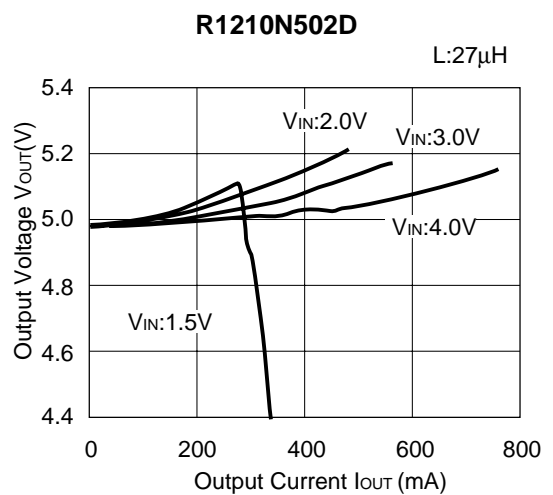
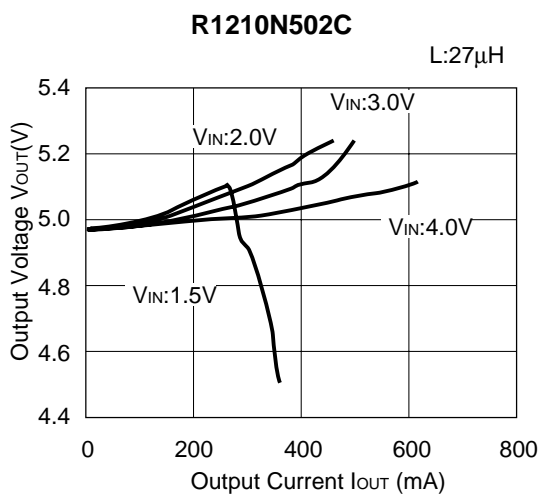
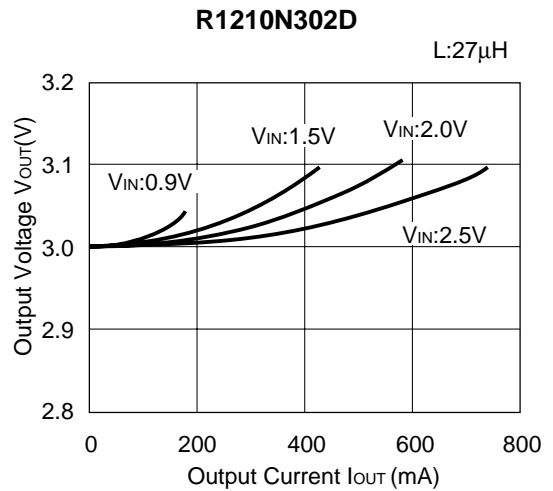
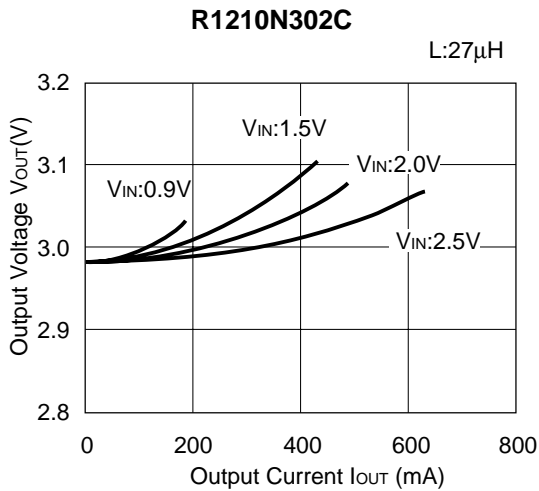

### 2) Efficiency vs. Output Current

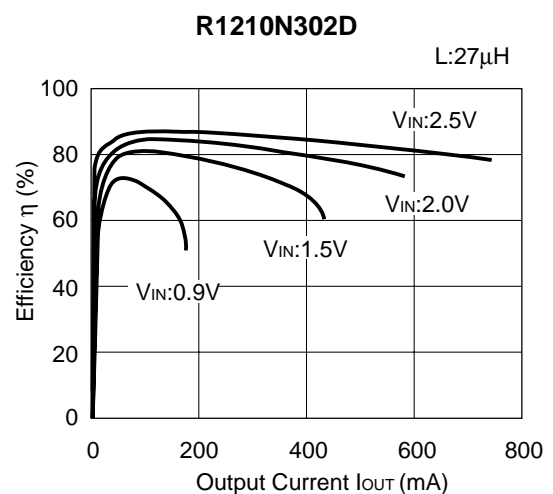
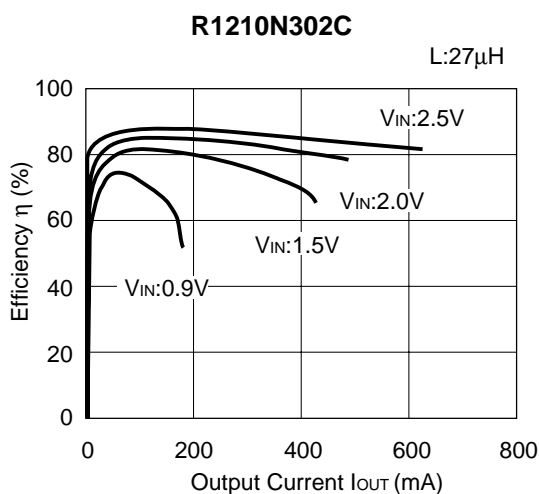

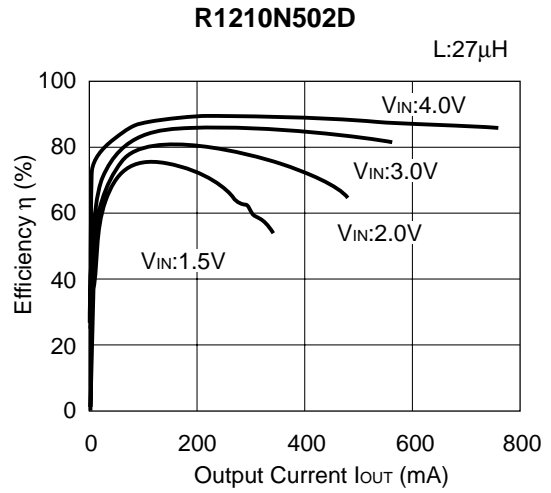
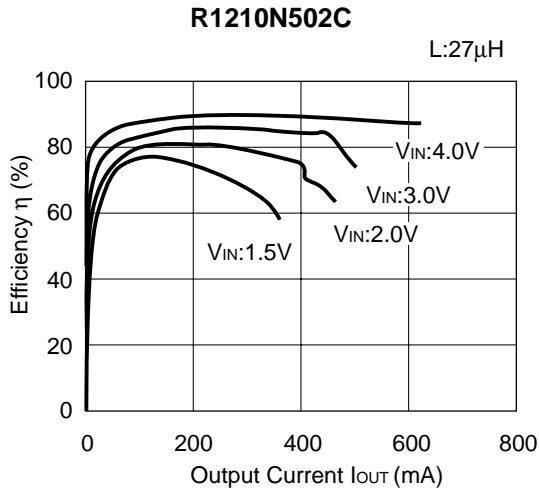

3) Ripple Voltage vs. Output Current

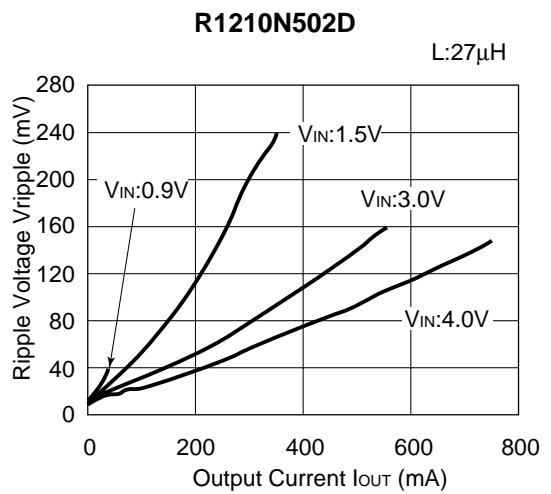
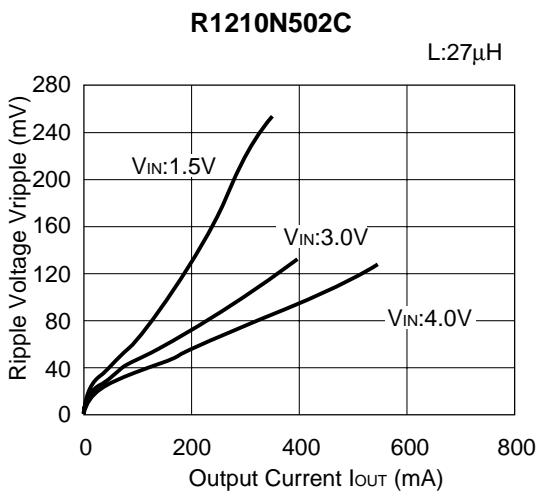
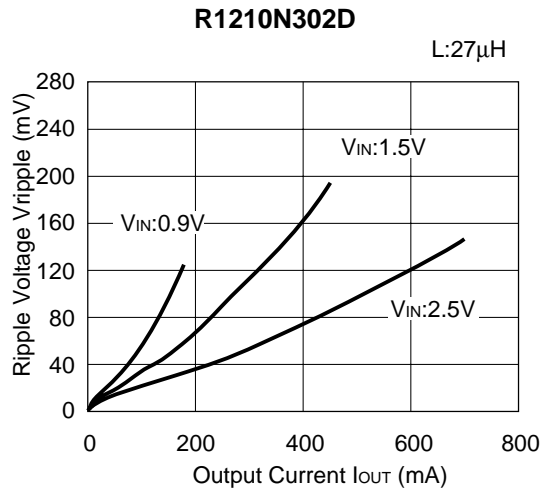
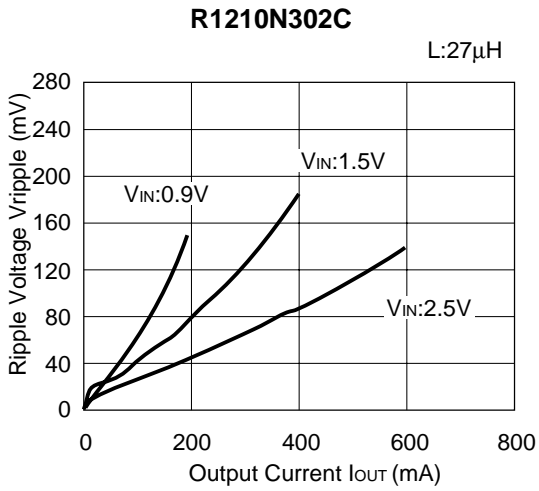



4) Start-up Voltage/ Hold-on Voltage vs. Output Current (T<sub>opt</sub>=25°C)

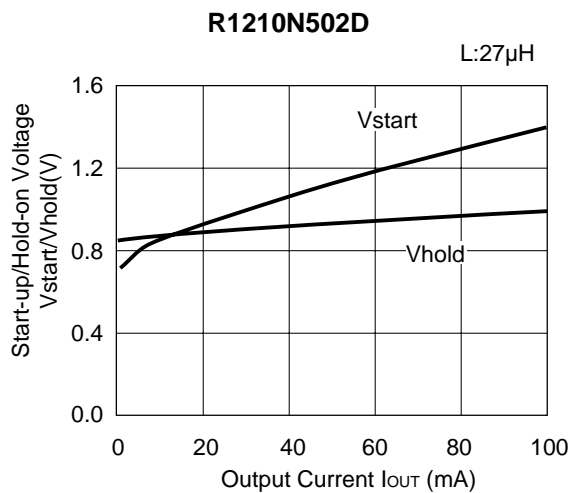
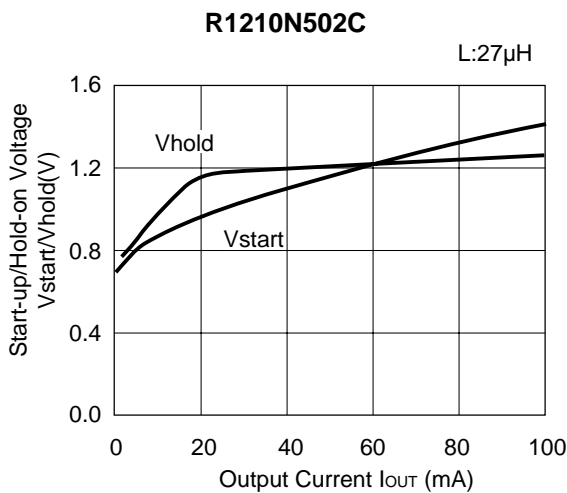
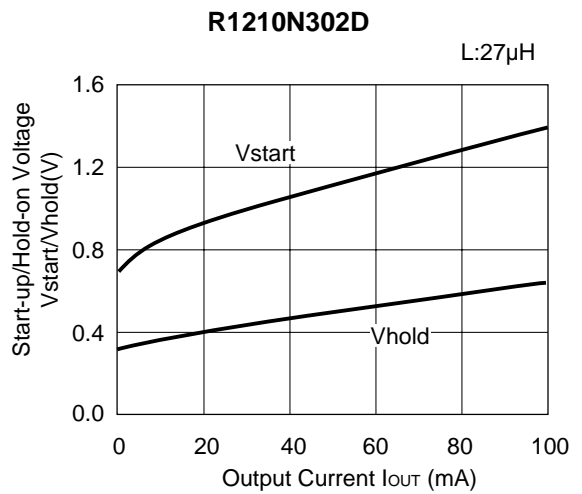
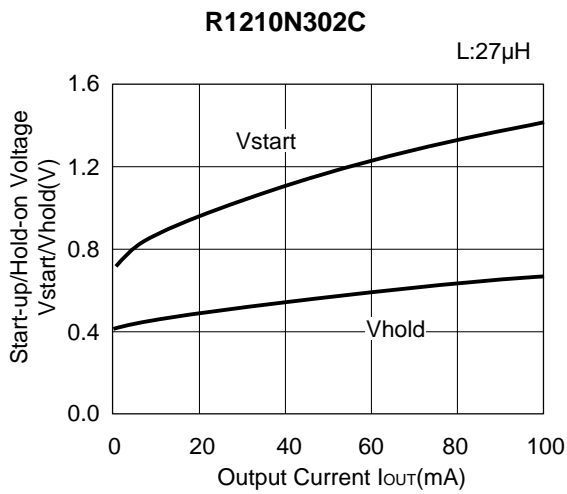

5) Output Voltage vs. Temperature

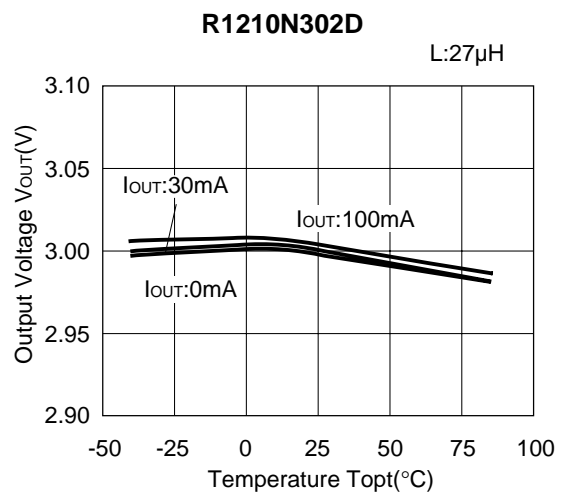
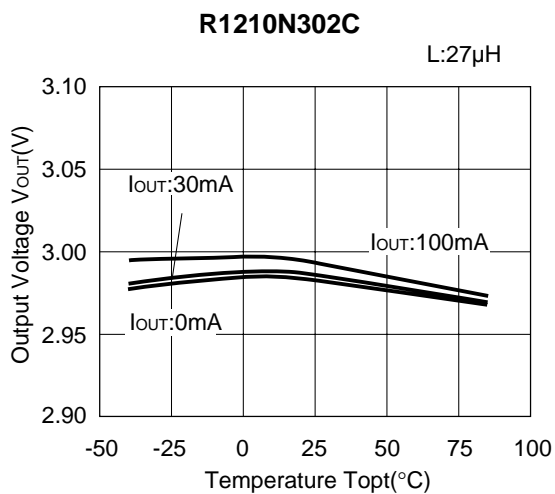

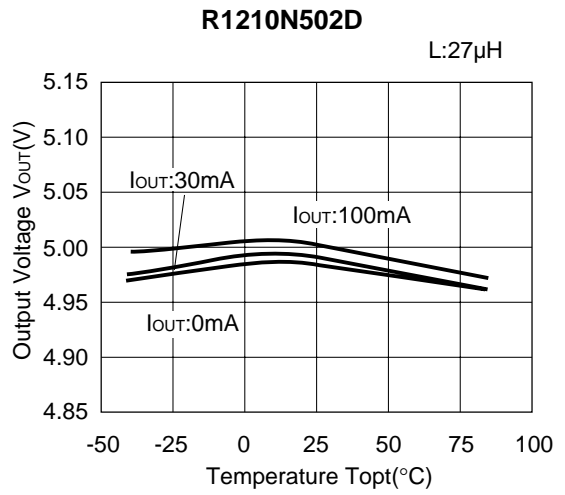
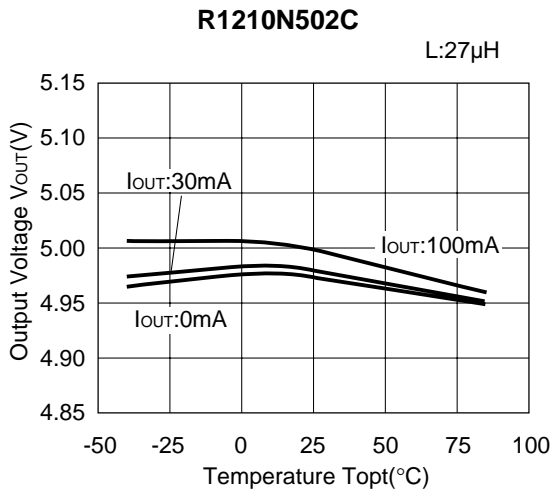

6) Supply Current 1 vs. Temperature

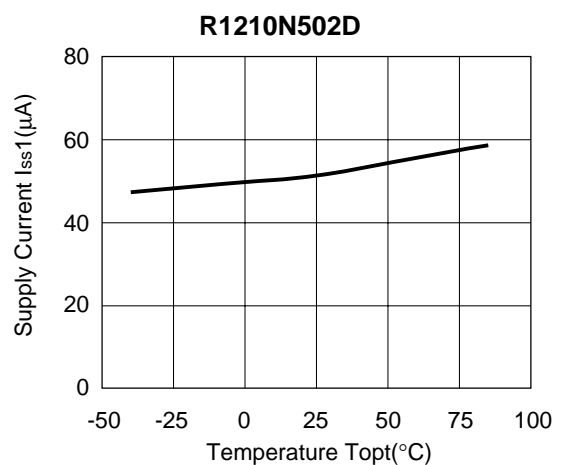
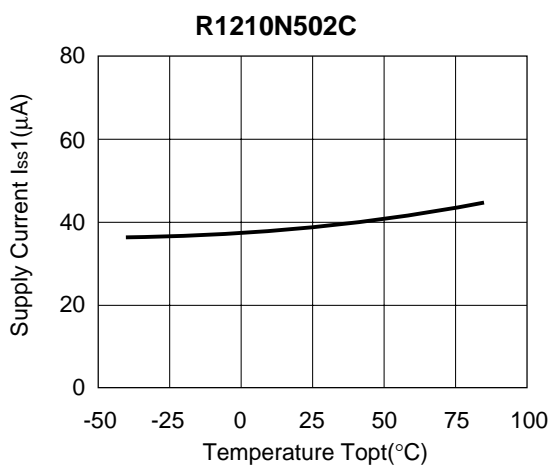
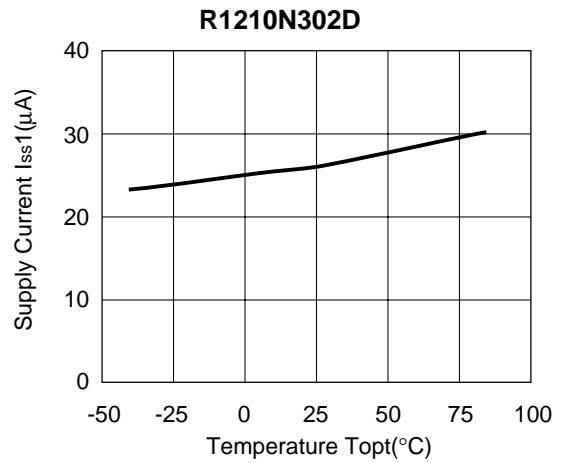
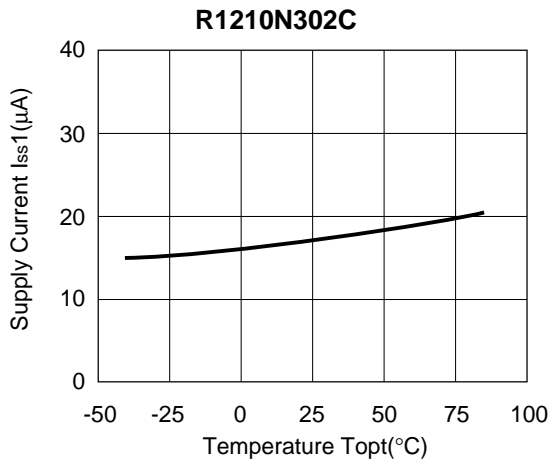

7) Supply Current 2 vs. Temperature

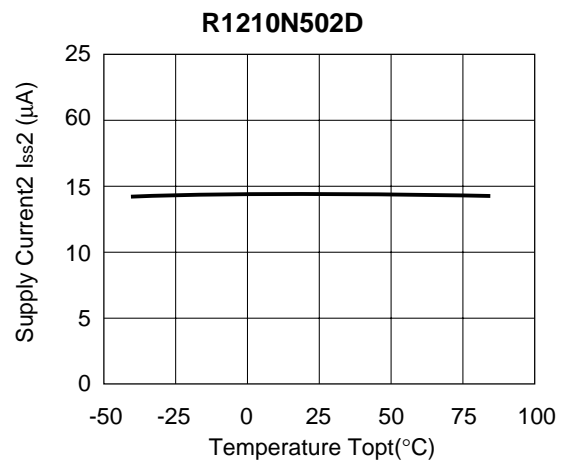
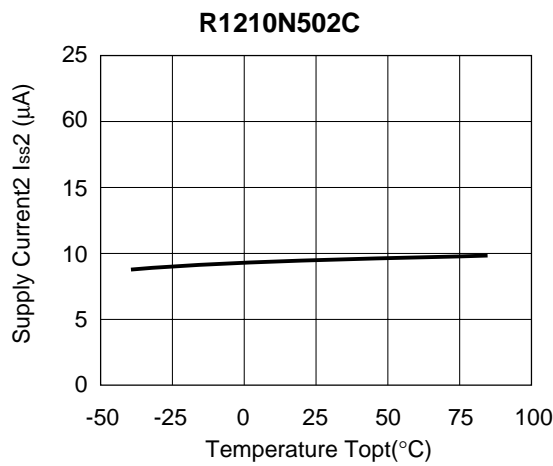
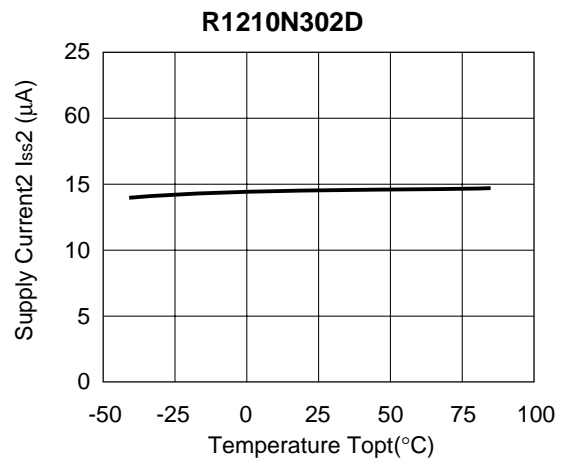
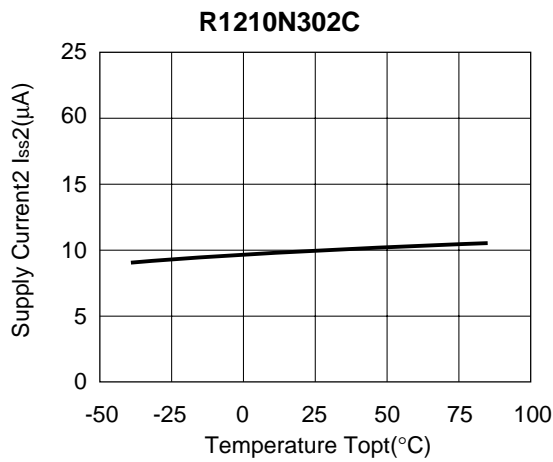

8) Supply Current 3 vs. Temperature

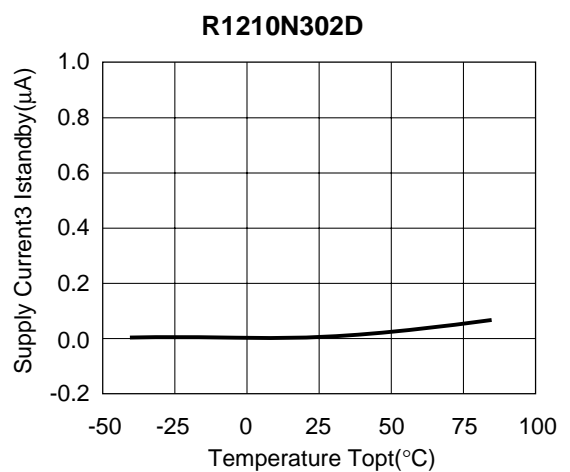
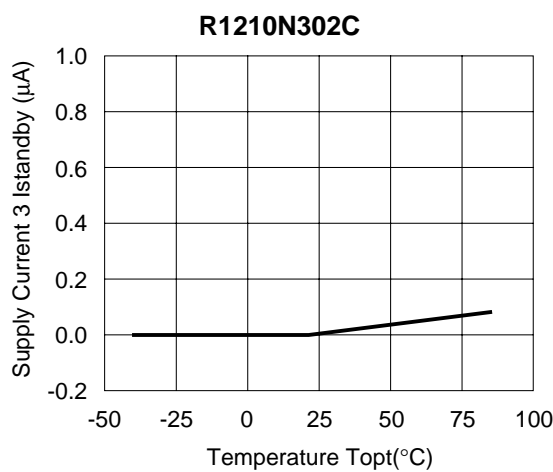

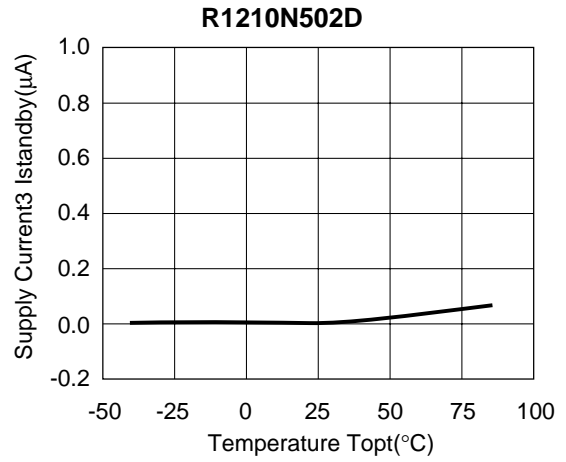
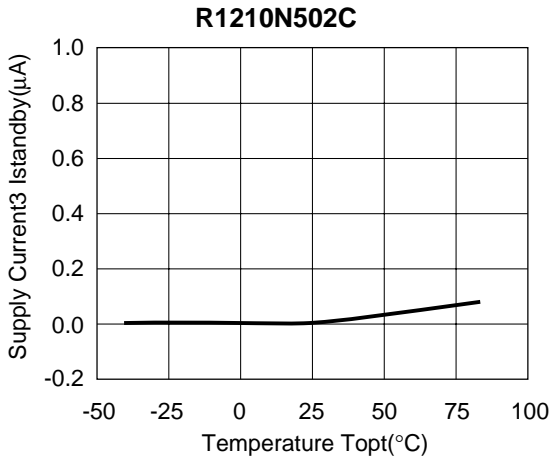

**9) Oscillator Frequency vs. Temperature**

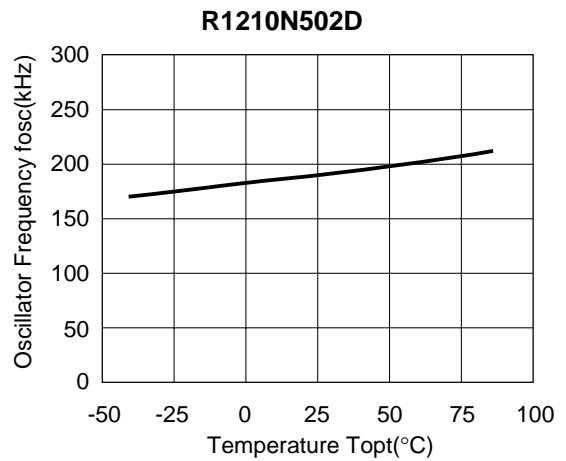
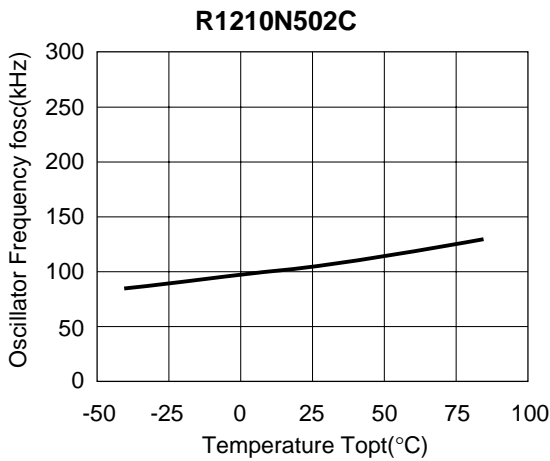
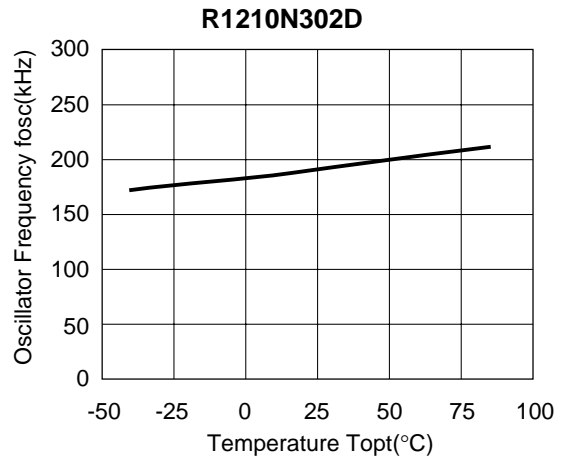
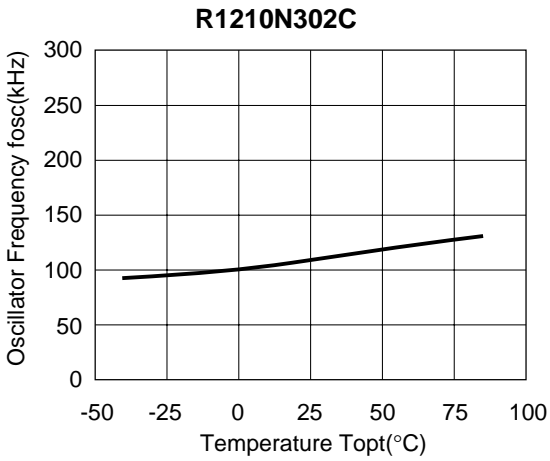

10) Maximum Duty Cycle vs. Temperature

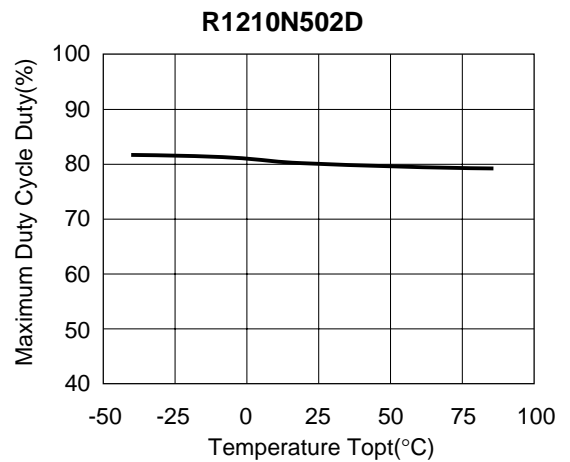
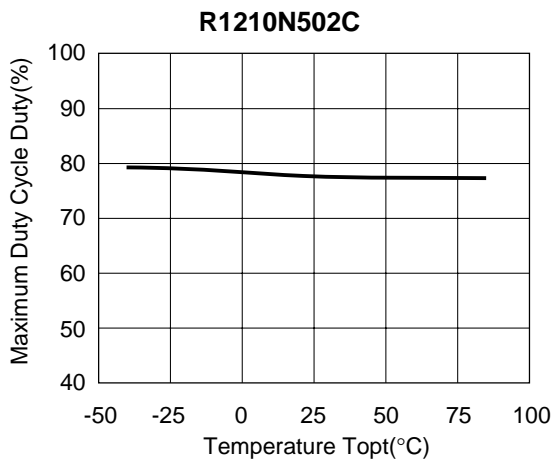
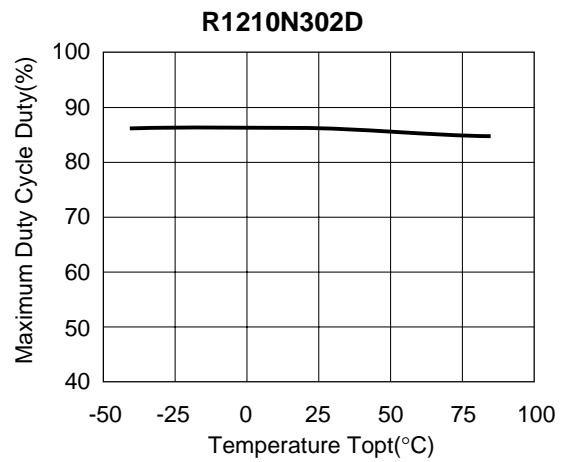
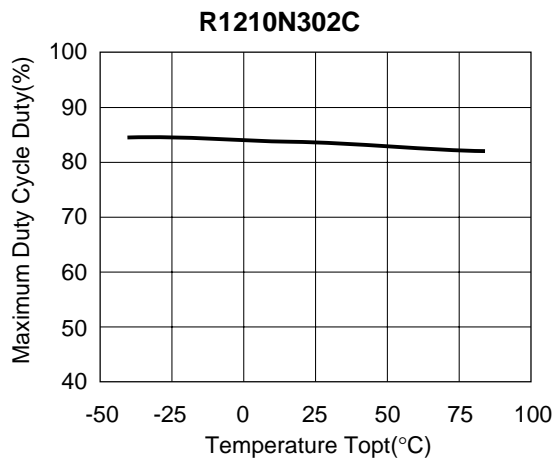

11) EXT "H" Output Current vs. Temperature

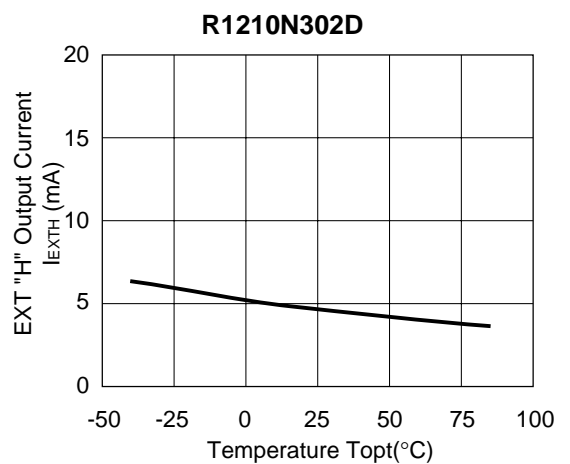
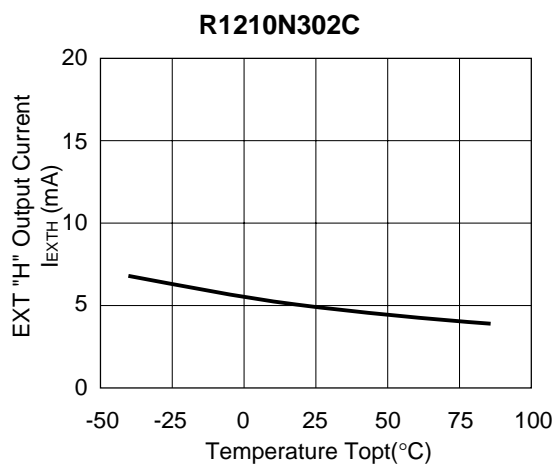

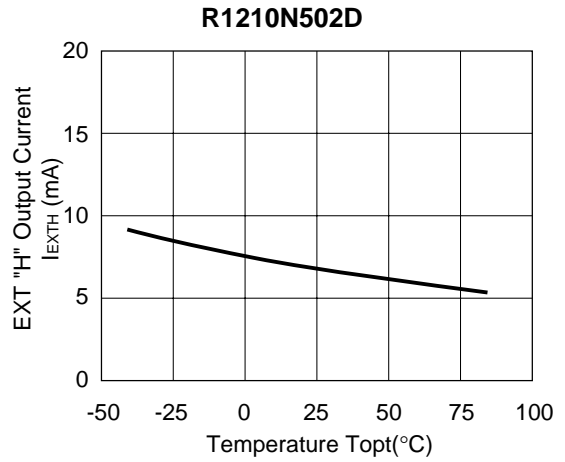
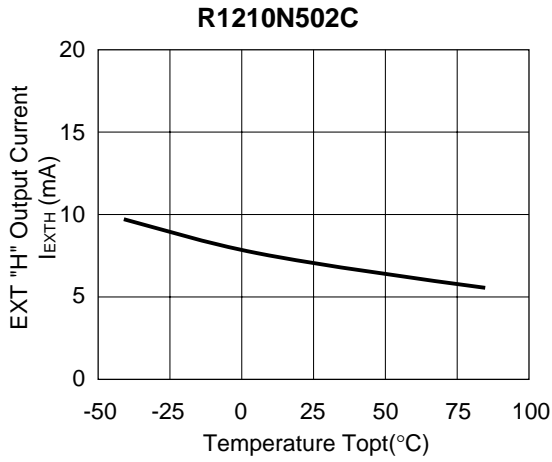

12) EXT "L" Output Current vs. Temperature

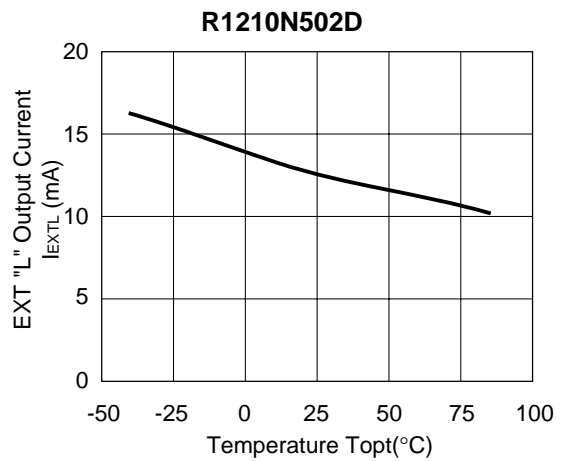
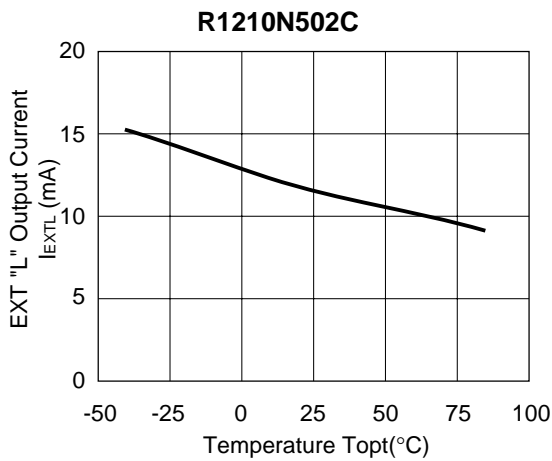
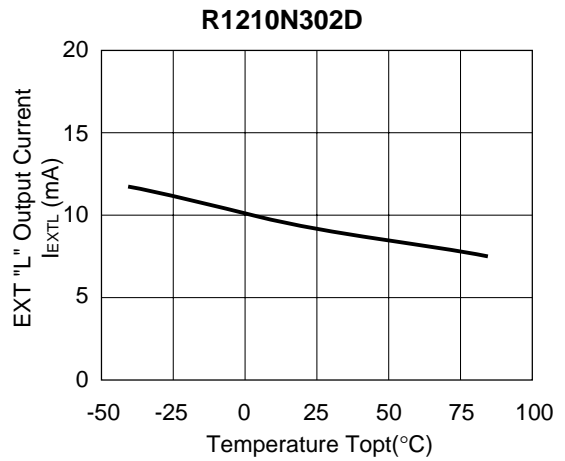
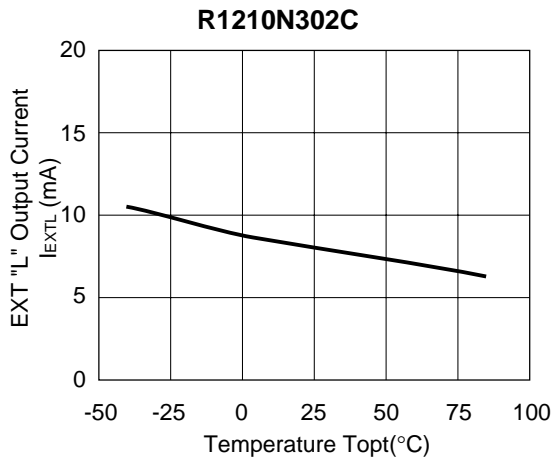

13) CE "H" Input Voltage vs. Temperature

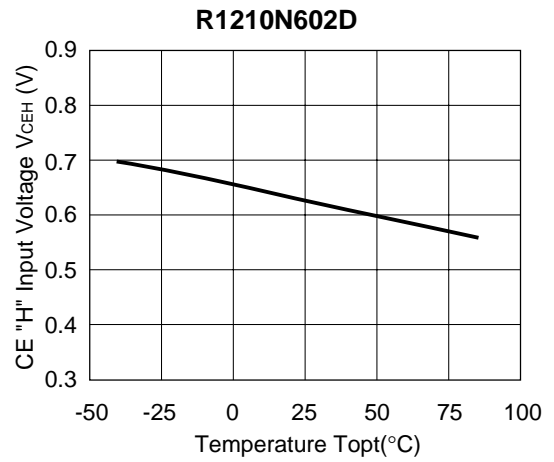
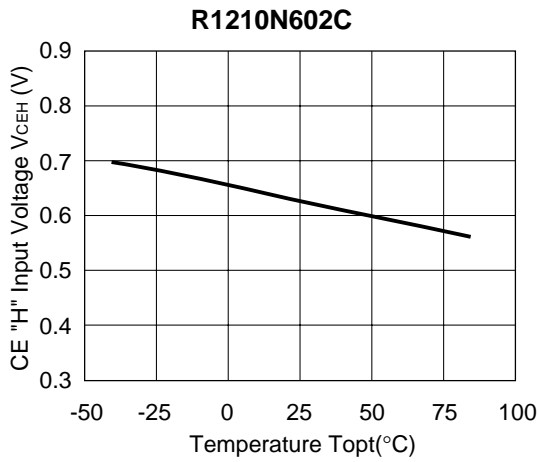

14) CE "L" Input Voltage vs. Temperature

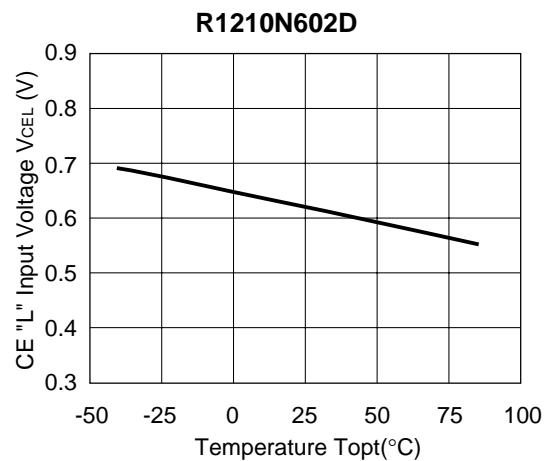
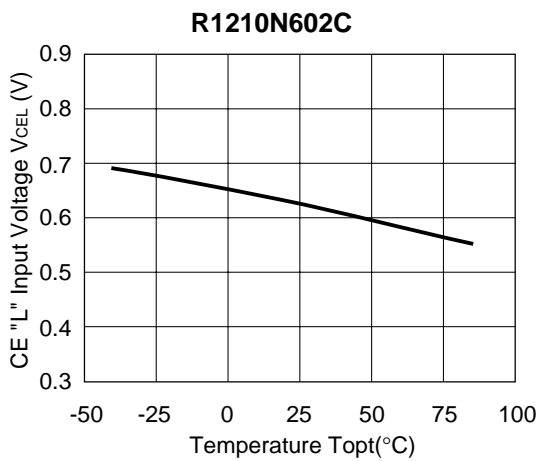

15) Output Waveform at Power-on (Topt=25°C)

((R1210N502C)) (VIN: 0V→3.0V)

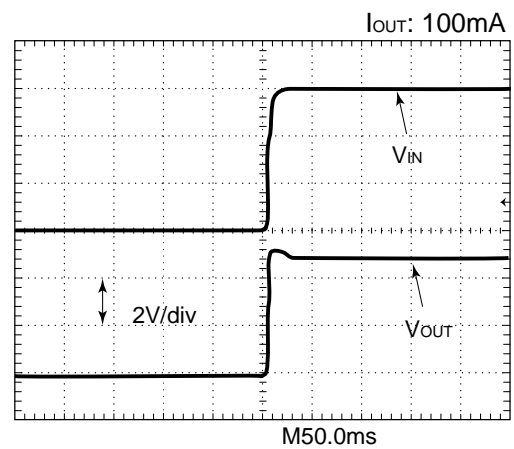
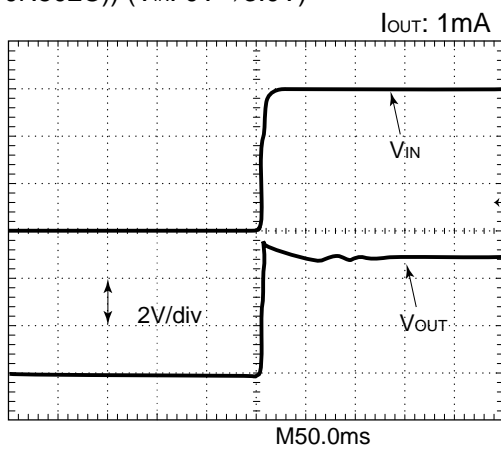

# R1210Nxx2x

((R1210N502D)) ( $V_{IN}$ : 0V→3.0V)

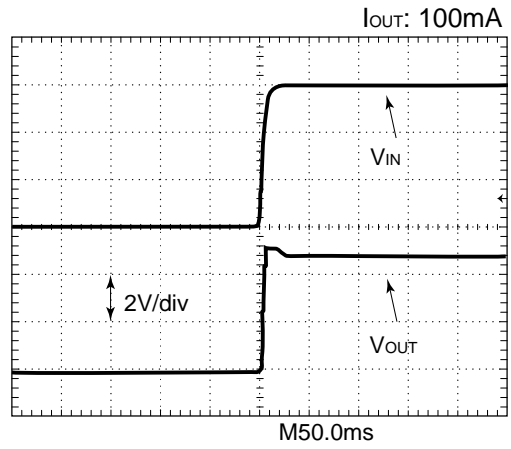
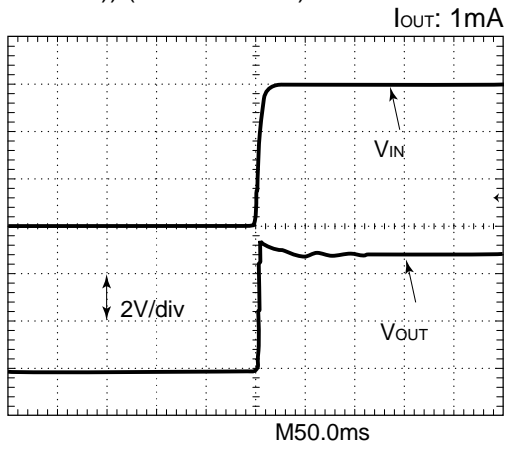

((R1210N302C)) ( $V_{IN}$ : 0V→1.5V)

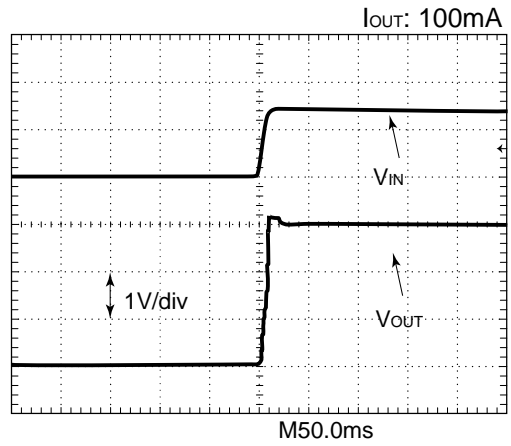
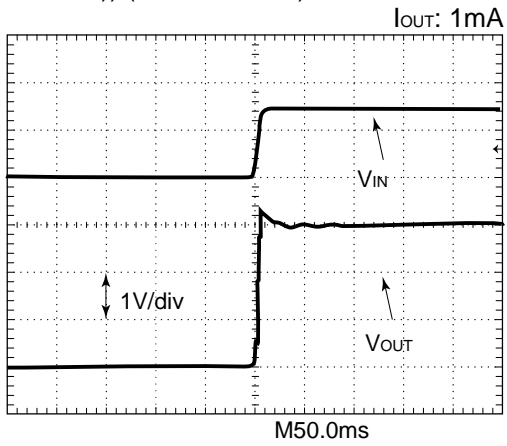

((R1210N302D)) ( $V_{IN}$ : 0V→1.5V)

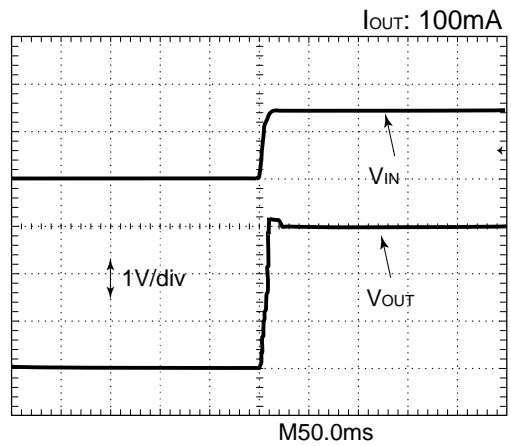
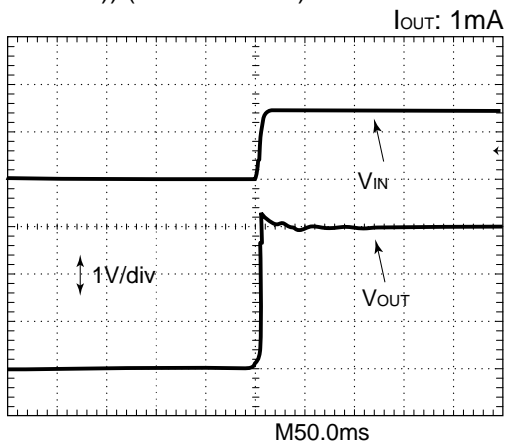

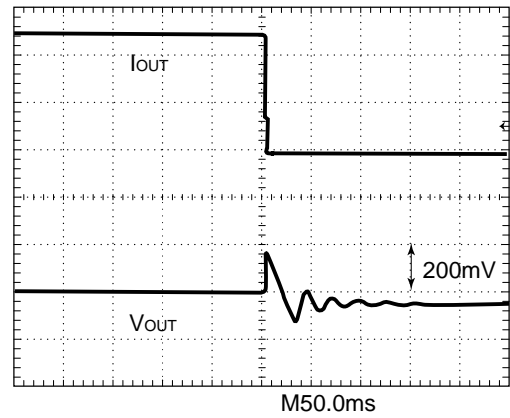
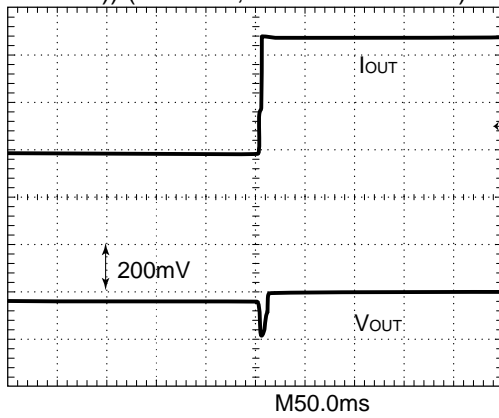
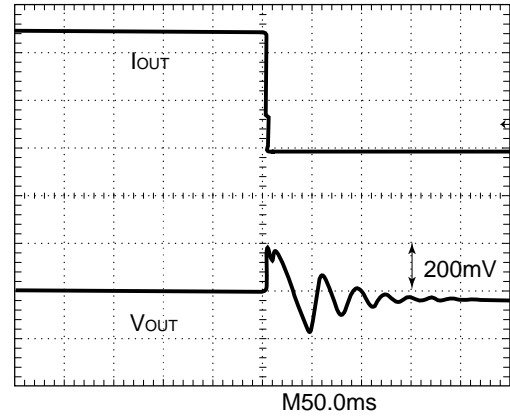
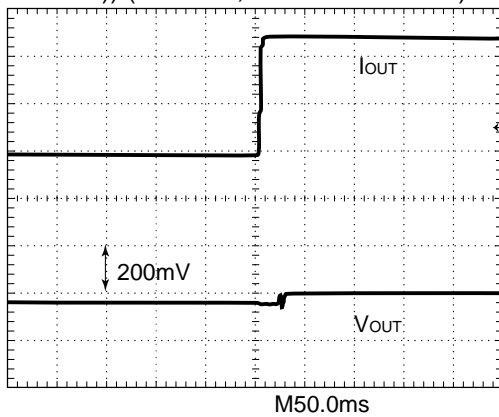
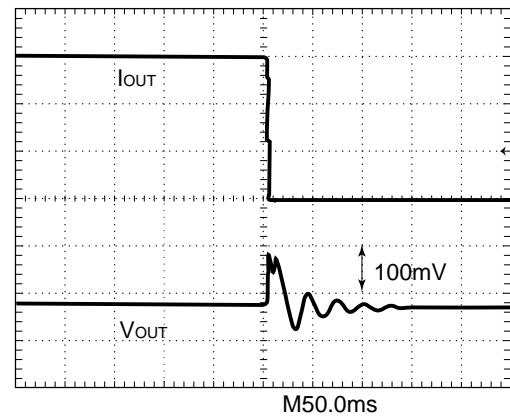
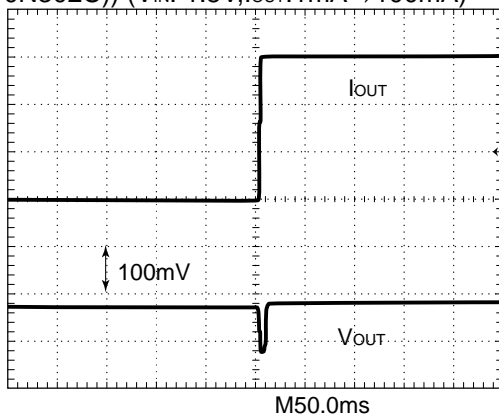

**16) Load Transient Response (T<sub>opt</sub>=25°C)**((R1210N502C)) (V<sub>IN</sub>: 3.0V, I<sub>OUT</sub>: 1mA→200mA)((R1210N502D)) (V<sub>IN</sub>: 3.0V, I<sub>OUT</sub>: 1mA→200mA)((R1210N302C)) (V<sub>IN</sub>: 1.5V, I<sub>OUT</sub>: 1mA→100mA)

((R1210N302D)) ( $V_{IN}: 1.5V, I_{OUT}: 1mA \rightarrow 100mA$ )

